

0-90° DRILLING AND MILLING HEAD
TÊTE DE PERÇAGE - FRAISAGE 0-90°

0-90° BOHR -UND FRAESKOPF
UNIDAD PARA FORAR - FRESAR 0-90°

TESTA DI FORATURA - FRESATURA ANGOLARE 0-90°

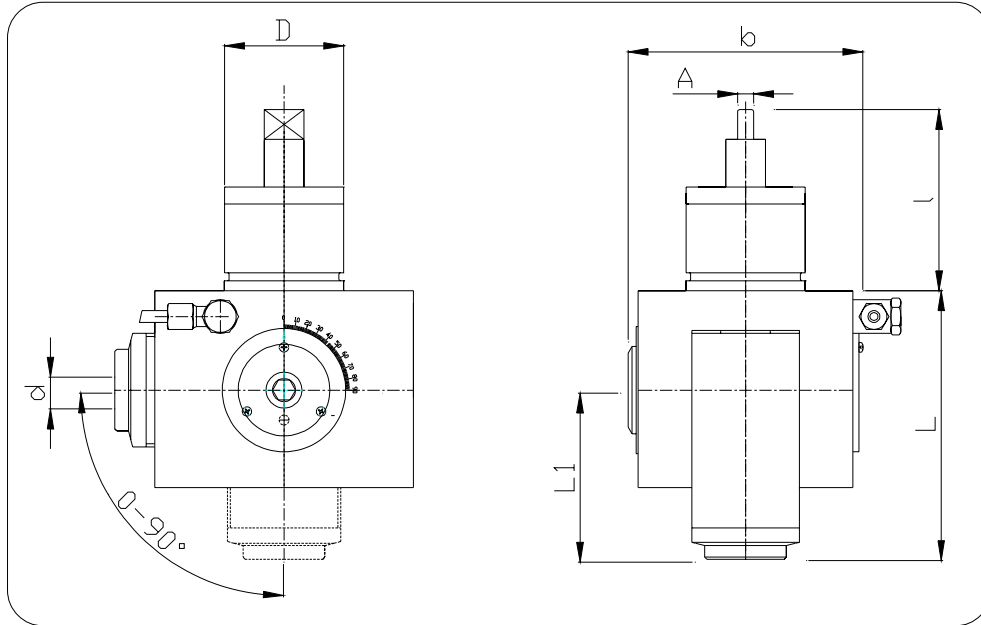

N. Cod.	Dh6	d	A	l	L	L1	b	n. Max	n1/n2	Nm	Kg.
HE60ME16	60	1-16 ER 25	7,9	91	140	85	116	6000	1:1	25	9,000

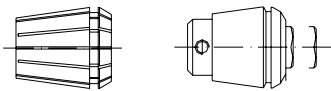

ACCESSORI
ACCESSORIES
ACCESSOIRES
ZUBEHÖR
ACCESORIOS